



Traditional Glass door Refrigerator

BR650-GA

BR650-GD

SPECIFICATION (Refrigerator)



Analog

Digital

Model	BR650-GA / GD
Dimension /L (W x D x H)	650x580 x1850 / 386L
Temp.	0°C ~ 10°C
Cooling type	Fan air circulation
Power Consumption	69.5Kwh
Shelves	Coated wires / 4
Light	LED
Power	110V/220V, 50/60Hz

*Power can be adjustable following upon request.

Traditional Glass door Freezer

BF650-GA

BF650-GD

SPECIFICATION (Freezer)



Analog (Fan / Direct)

Digital (Fan / Direct)

Model	BF650-GA / GD
Dimension /L (W x D x H)	650x580 x1850 / 386L
Temp.	0°C ~ -12°C
Cooling type	Fan /Direct (Cooling pipe)
Power Consumption	69.5Kwh
Shelves	Coated wires / 4
Light	LED
Power	110V/220V, 50/60Hz

*Power can be adjustable following upon request.

Upright Reach-In Top Mount

Cabinet Construction

- Open spaced interior with no walls between compartments.
- Galvanized steel top, bottom and rear.
- 2.5" thick high density polyurethane insulation.

Refrigeration System

- Top mounted, self-contained condensing unit is cartridge type with fully detachable design.
- Full-length air duct and airflow guard ensure optimal cold air circulation.
- Self-maintaining, energy-efficient condensate drain pan requires no external drains or electric heaters.
- Auto-reverse condenser fan motor supports compressor ventilation and condenser coil cleaning.
- Pressure relief devices allow rapid cabinet re-entry.
- Audible overheat protection alarm for compressor and condenser coil.

Doors

- Frame heaters prevent exterior moisture build up.
- Self-closing with adjustable torsion system for a positive seal with Theft free preinstalled locks.
- Snap-in magnetic Ridge-lined gasket for ease of cleaning



e-Catalog

Bradford

The SKY Valley I-901, 142 Gasan Digital 1Ro, Geumcheon-Gu, Seoul, Korea 08507
<https://www.bradfordkorea.com> / TEL: +82-(0)2-859-7807 / FAX: +82-2-859-7808 / Email: help@bradfordkorea.com

MADE IN KOREA

BR075-1ST

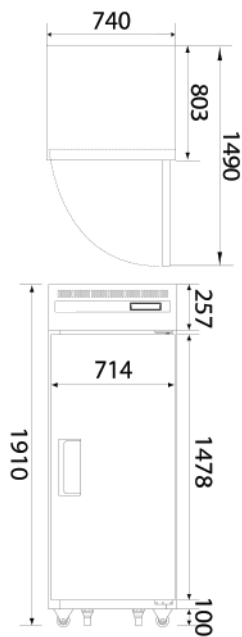

BF0150-2ST

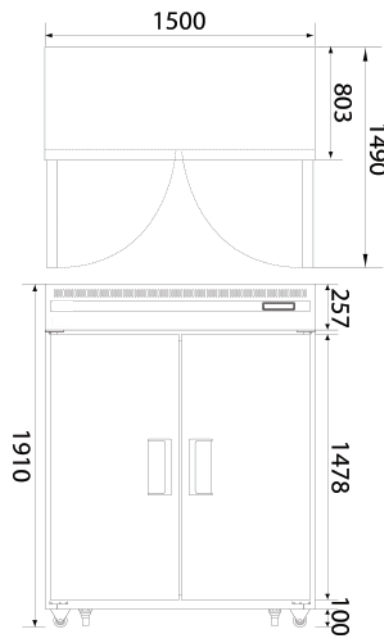

BHD58-1HT

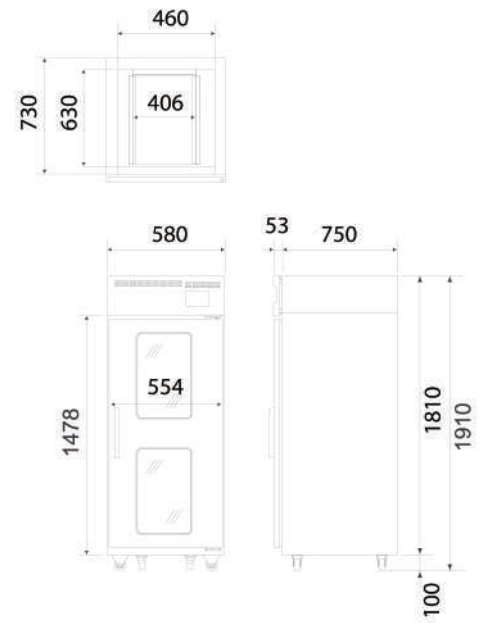

U-Trap (Cold air trap)



Slide In-Out Cartridge condensing unit

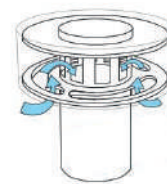

Vacuum Relief Valve



Ridge-lined door gasket

SPECIFICATIONS

Model	R/F	Dimension (mm)	Vol. (L)	Refrigerant	HP	AIR FLOW
BR075-1ST	R	740 x 800 x 1910(H)	557	R-134A	1/3	
BF075-1ST	F	740 x 800 x 1910	557	R-404A	1/2	
BR0150-2ST	R	1500 x 800 x 1910	1250	R-134A	1/3	
BF0150-2ST	F	1500 x 800 x 1910	1250	R-404A	1/2 x2	
BH0150-2ST	R/F	1500 x 800 x 1910	600/600	R-134A	1/3 (R)	
				R-404A	1/2 (F)	
Dough Con. BHD58-1HT	H/R	580 x 800 x 1985	18 pans	R-134A	1/3+ 980W/h	

Specifications and features described in the leaflet can be changed and updated without prior notice.

Under counters & Prep tables Back Mount

Refrigeration System

- Back mounted, self-contained and fully detachable slide in-out condensing unit design.
- Front air breathing for flexibility in installation.
- Full-length air duct ensures optimal cold air circulation.
- Self-maintaining, energy-efficient condensate drain pan requires no external drains or electric heaters.
- Auto-reverse condenser fan motor supports compressor ventilation and condenser coil cleaning.
- Pressure relief devices allow rapid cabinet re-entry.

Doors

- Pre-Installed Door Locks provides security options for any situation.
- Self-closing with adjustable torsion system for a positive seal.
- Snap-in magnetic Ridge-lined gasket for ease of cleaning.

Heavy Duty Swivel Casters

Standard 5" with locks on front set. Optional 3" swivel caster or height-adjustable leg replacements also available.



e-Catalog

Bradford

The SKY Valley I-901, 142 Gasan Digital 1Ro, Geumcheon-Gu, Seoul, Korea 08507
<https://www.bradfordkorea.com> / TEL: +82-(0)2-859-7807 / FAX: +82-2-859-7808 / Email: help@bradfordkorea.com

MADE IN KOREA

BFU70-1SR

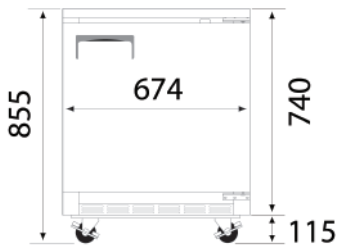
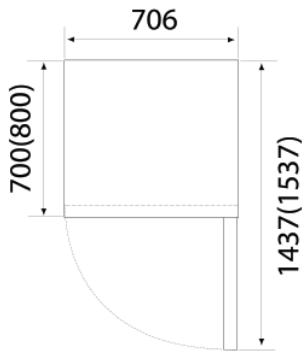

BRU120-2SR

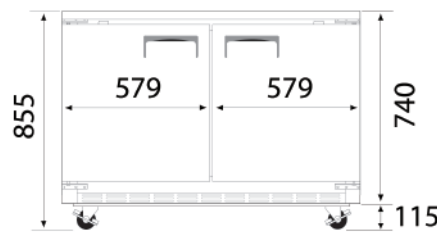
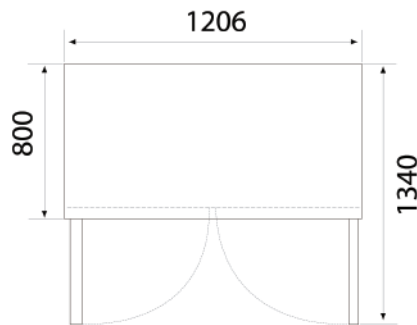

BRU180-3SR

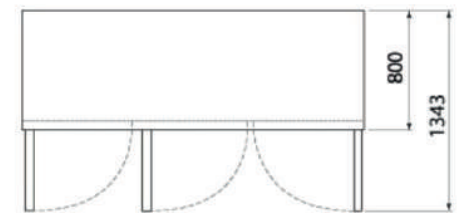
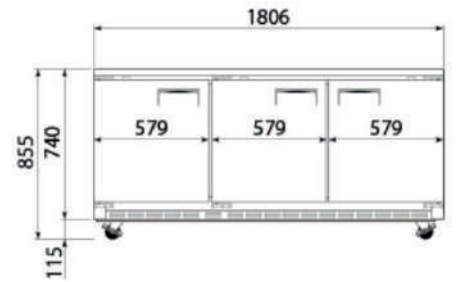

U-Trap (Cold air trap)



Slide In-Out Cartridge condensing unit

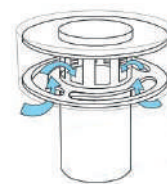

Vacuum Relief Valve



Ridge-lined door gasket

SPECIFICATIONS

Model	R/F	Dimension (mm)	Vol. (L)	Refrigerant	HP	AIR FLOW
	R	700 x 800 x 850(H)	150	R-134A	1/5	
BRU120-2SR	R	1205 x 800 x 850	335	R-134A	1/5	
BRU150-2SR	R	1505 x 800 x 850	425	R-134A	1/4	
BRU180-3SR	R	1805 x 800 x 850	518	R-134A	1/3	
BFU70-1SR	F	700 x 800 x 850	150	R-134A	1/3+	
BFU120-1SR	F	1200 x 800 x 850	335	R-134A	1/3+	
BFU150-2SR	F	1800 x 800 x 850	425	R-404A	1/2	

Specifications and features described in the leaflet can be changed and updated without prior notice.

Pizza/Sandwich prep table Back mount / Mega top

Cabinet Construction

- Open spaced interior with no walls between cabinet compartments.
- Vented stainless steel panel between top pan area and cabinet catches food debris.
- 2.5" thick high density polyurethane insulation ensures temperature stability and conserves energy.

Refrigeration System

- Back mounted, self-contained and fully detachable slide in-out condensing unit design.
- Front air breathing for flexibility in installation.
- Full-length air duct ensures optimal cold air circulation.
- Self-maintaining, energy-efficient condensate drain pan requires no external drains or electric heaters.
- Auto-reverse condenser fan motor supports compressor ventilation and condenser coil cleaning.
- Pressure relief devices allow rapid cabinet re-entry.



Doors

- Frame heaters prevent exterior moisture build up.
- Self-closing with adjustable torsion system for a positive seal.
- Snap-in magnetic Ridge-lined gasket for ease of cleaning.

Preparation Area

- Mega-top fits three rows of NSF certified polycarbonate 6 deep pans (see table for quantity)
- 1/2" thick, foam insulated lid keeps top pan area cold and prevents moisture build-up.
- 91/8" deep cutting board is removable for ease of cleaning



e-Catalog

Bradford

The SKY Valley I-901, 142 Gasan Digital 1Ro, Geumcheon-Gu, Seoul, Korea 08507
<https://www.bradfordkorea.com> / TEL: +82-(0)2-859-7807 / FAX: +82-2-859-7808 / Email: help@bradfordkorea.com

MADE IN KOREA

BRP90-1SS

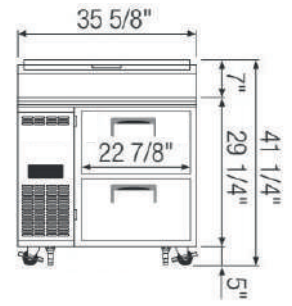
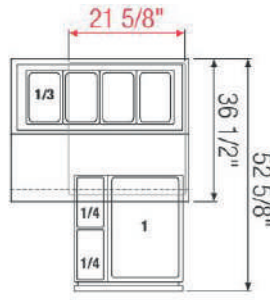

BRP150-2SS

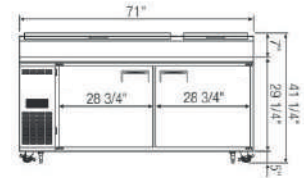
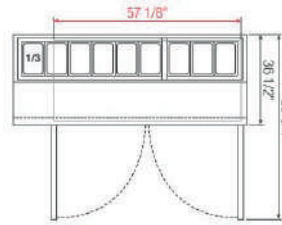

BRM70-1SR

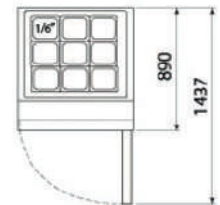
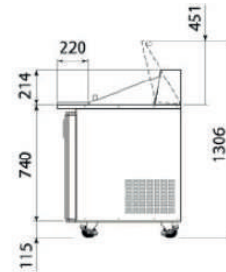
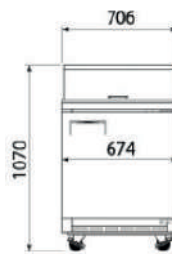

BRM120-2SR

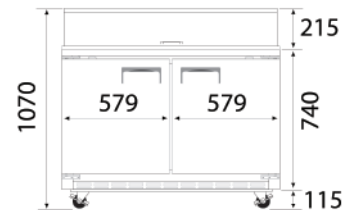
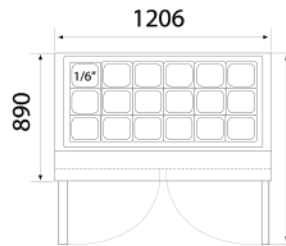

U-Trap (Cold air trap)



Slide In-Out Cartridge condensing unit

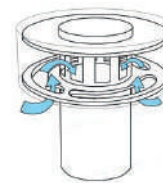

Vacuum Relief Valve



Ridge-lined door gasket

SPECIFICATIONS

Model	R/F	Dimension (mm)	Vol. (L)	Refrigerant	HP	AIR FLOW
BRP90-1SS	R	905 x 845 x 1030(H)	210	R-134A	1/4	
BRP150-2SS	R	1505 x 845 x 1030	440	R-134A	1/4	
BRP180-2SS	R	1805 x 845 x 1030	555	R-134A	1/3	
BRM70-1SR	R	705 x 890 x 1070	183	R-134A	1/5	
BRM120-2SR	R	1205 x 890 x 1070	335	R-134A	1/4	
BRM150-2SR	R	1205 x 890 x 1070	425	R-134A	1/3	

Specifications and features described in the leaflet can be changed and updated without prior notice.

BAKERY SHOWCASE

Reliable power operation

Digital temperature controller adopted for easy temperature setting inside of the showcase with ability to select the defrost time setting for your best working conditions.

Anti-fog design

Paired glass (Double paned glasses) adopted for fog free glass and energy saving supported with ACAF system "air curtain anti-fog systems" for the front glass wall to boost fog resistance if necessary.

Customizable design and various product lines

You can also select various designs and colors for each different purpose showcases made of fortified glass. Moreover, we support various types of products following upon our customer demands such as Supermarket, Meat shop, Bakery & Coffee shop, convenient store and beverage display etc.



e-Catalog

"We can meet all customized specifications that our clients request including various Colors, Sizes, Purposes (bakery, Meat, flower, aqua culture, vegetables etc.) and technical requirement."

Bradford

The SKY Valley I-901, 142 Gasan Digital 1Ro, Geumcheon-Gu, Seoul, Korea 08507
<https://www.bradfordkorea.com> / TEL: +82-(0)2-859-7807 / FAX: +82-2-859-7808 / Email: help@bradfordkorea.com

MADE IN KOREA

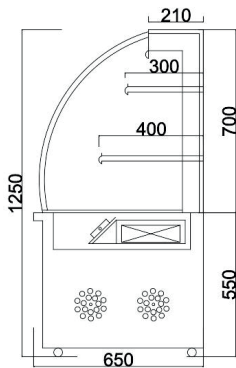
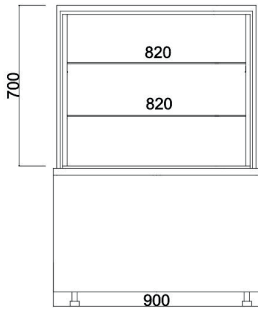
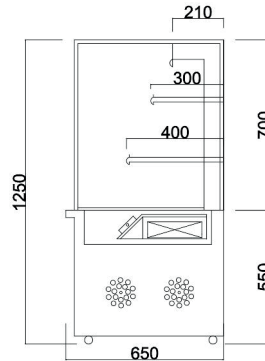
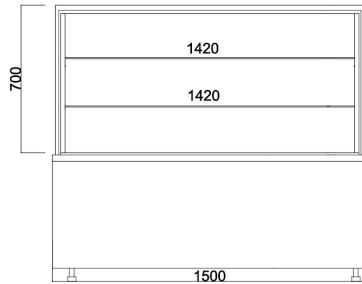
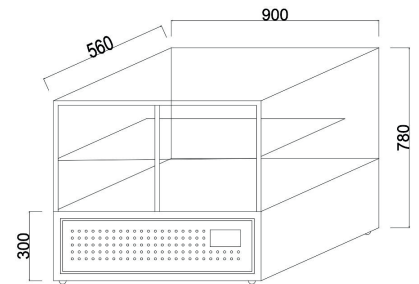
BF90-S/R**BF150-S/R****BF90-ST**

SPECIFICATIONS

Model	R/F	Dimension (mm)	Vol. (L)	Refrigerant	HP
Floor model					
BF90-S/R	R	900 x 650 x 1250(H)	410	R-404A	1/3
BF120-S/R	R	1200 x 650 x 1250	545	R-404A	1/3
BF150-S/R	R	1500 x 650 x 1250	680	R-404A	1/2
BF180-S/R	R	1800 x 650 x 1250	820	R-404A	3/4
BF240-S/R	R	2400 x 650 x 1250	1090	R-404A	1
Table Top Showcase					
BF90-ST	R	900 x 560 x 765	385	R-134A	1/3
BF150-ST	R	1500 x 560 x 765	407	R-134A	1/3
BF180-ST	R	1800 x 560 x 765	765	R-134A	3/4

Specifications and features described in the leaflet can be changed and updated without prior notice.

MULTI PURPOSE SHOWCASE

Grab & Go, Donut, Meat and Vat

Reliable power operation

Digital temperature controller adopted for easy temperature setting inside of the showcase with ability to select the defrost time setting for your best working conditions.

Anti-fog design

Paired glass (Double paned glasses) adopted for fog free glass and energy saving supported with ACAF system "air curtain anti-fog systems" for the front glass wall to boost fog resistance if necessary.

Customizable design and various product lines

You can also select various designs and colors for each different purpose showcases made of fortified glass. Moreover, we support various types of products following upon our customer demands such as Supermarket, Meat shop, Bakery & Coffee shop, convenient store and beverage display etc.



e-Catalog

"We can meet all customized specifications that our clients request including various Colors, Sizes, Purposes (bakery, Meat, flower, aqua culture, vegetables etc..) and technical requirement."

Bradford

The SKY Valley I-901, 142 Gasan Digital 1Ro, Geumcheon-Gu, Seoul, Korea 08507
<https://www.bradfordkorea.com> / TEL: +82-(0)2-859-7807 / FAX: +82-2-859-7808 / Email: help@bradfordkorea.com

MADE IN KOREA

BF90-RGG

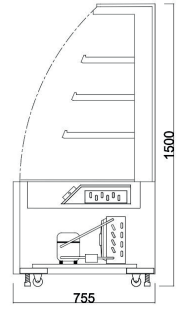
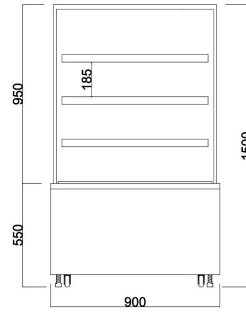

BF125-SN (Donut)

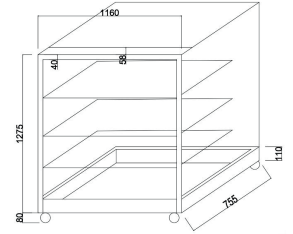
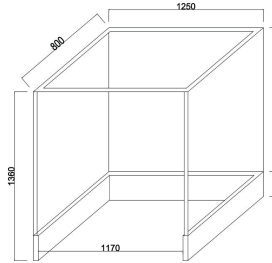

BF120-SVT

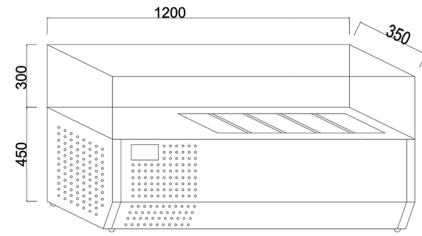

BF120-RM

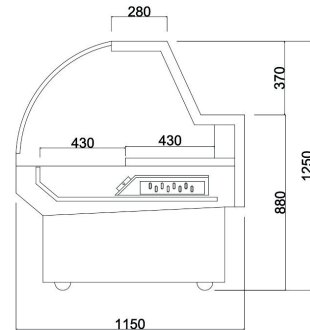

SPECIFICATIONS

Model	R/F	Dimension (mm)	Vol. (L)	Refrigerant	HP
Grab & Go					
BF90-RGG	R	900 x 750 x 1350(H)	540	R-404A	1/3
BF120-RGG	R	1200 x 750 x 1350	720	R-404A	1/3
BF150-RGG	R	1500 x 750 x 1350	900	R-404A	1/2
Donut Showcase					
BF125-SN (No. Refrig.)	R	1250 x 800 x 1400	1300	N/A	N/A
VAT Showcase, Table top					
BF90-SVT	R	900 x 340 x 460	73	R-134A	1/3
BF120-SVT	R	1200 x 340 x 460	97	R-134A	1/3
BF150-SVT	R	1500 x 340 x 460	122	R-134A	1/2
Meat showcase, European					
BF120-RM	R	1200 X 1150 X 1250	545	R-404A	1/3
BF150-RM	R	1500 X 1150 X 1250	680	R-404A	1/2
BF180-RM	R	1800 X 1150 X 1250	820	R-404A	3/4

Specifications and features described in the leaflet can be changed and updated without prior notice.